

IP 67
ACCORDING TO
EN 60529:1989+HA1:2001
IEC 60529:2001

UL US
E 187490

RoHS
compliant

Pb
lead-free

SPECIFICATIONS

CONTACT RATING: Dependent upon contact material See Page 34.

MECHANICAL LIFE: 30,000 make-and-break cycles.

CONTACT RESISTANCE: 20 mΩ max. initial @ 2-4VDC
100mA for both silver and gold plated contacts.

INSULATION RESISTANCE: 1,000 MΩ min.

DIELECTRIC STRENGTH: 1,000 Vrms min. @sea level.

OPERATING TEMPERATURE: -40°C to 85°C.

MATERIALS

CASE & BUSHING: Glass filled nylon 6/6, flame retardant,
heat stabilized (UL94v-0).

ACTUATOR: Brass, chrome plated, internal O-ring seal.
Standard for all actuators.

SWITCH SUPPORT: Brass, tin plated.

CONTACT / TERMINALS: Copper alloy with Silver or gold plated.

(See Page 34)

HOW TO ORDER

MODEL NO.	ACTUATOR	BUSHING	TERMINATIONS	TERMINAL PLATING	SEAL	RoHS SOLDERING
-----------	----------	---------	--------------	------------------	------	----------------

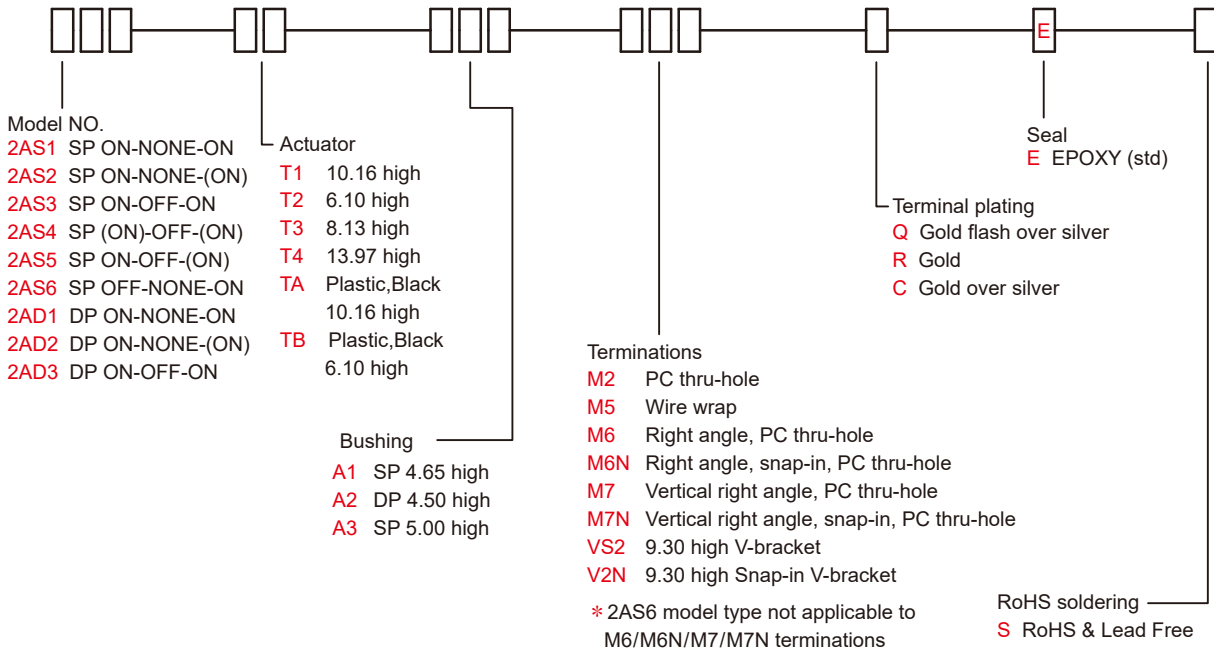

SWITCH FUNCTION

NO. POLES	UL/CSA MODEL NO.	MODEL NO.	SWITCH FUNCTION			CONNECTED TERMINALS / SCHEMATIC		
			POS.1	POS.2	POS.3	POS.1	POS.2	POS.3
SP	Q22A11	2AS1	ON	NONE	ON	2-3	N/A	2-1
	Q22A12	2AS2	ON	NONE	(ON)			
	Q22A13	2AS3	ON	OFF	ON		OPEN	
	Q22A14	2AS4	(ON)	OFF	(ON)			
	Q22A15	2AS5	ON	OFF	(ON)	OPEN	N/A	3-1
	Q22A16	2AS6	OFF	NONE	ON			
DP	Q22A21	2AD1	ON	NONE	ON	2-3,5-6	N/A	2-1,5-4
	Q22A22	2AD2	ON	NONE	(ON)			
	Q22A23	2AD3	ON	OFF	ON			

()=MOMENTARY

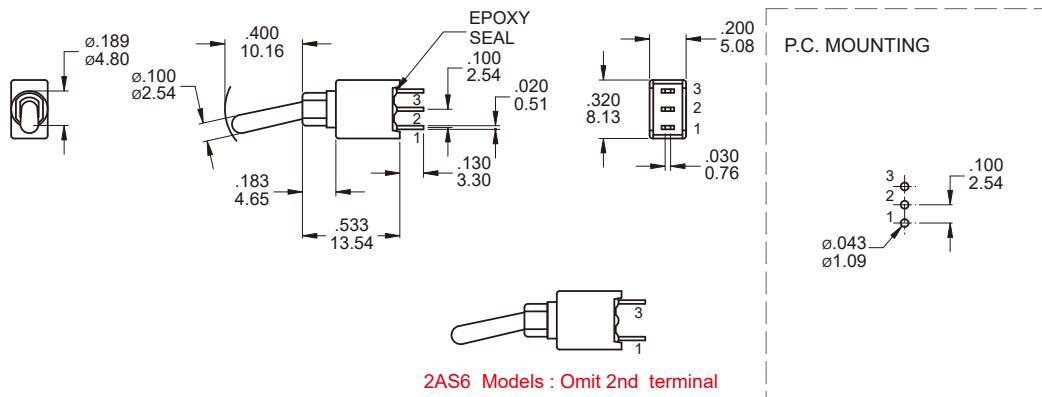
POLE OPTIONS
M2

SPDT

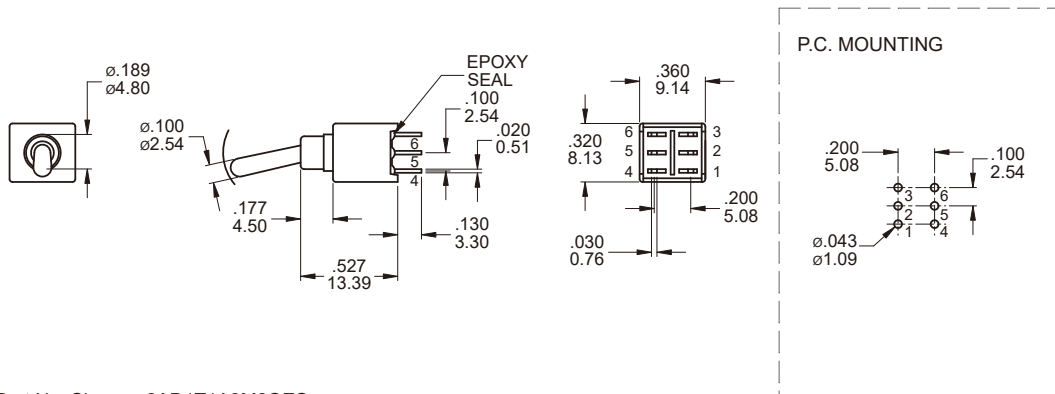
Part No. Shown : 2AS1T1A1M2RES

M2

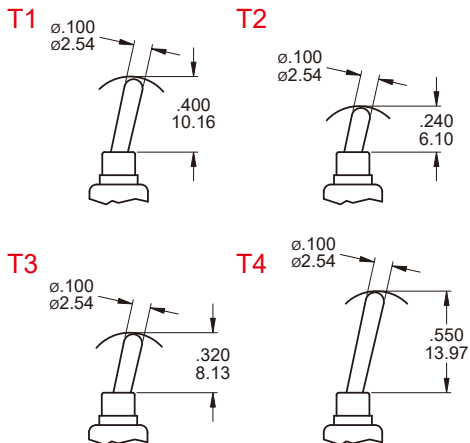
DPDT

Part No. Shown : 2AD1T1A2M2QES

ACTUATOR OPTIONS

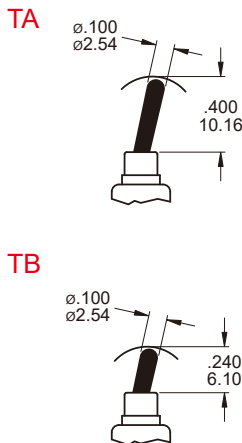
Actuator shown with A1 Bushing,
sub .020 (0.50) for A3 Bushing.

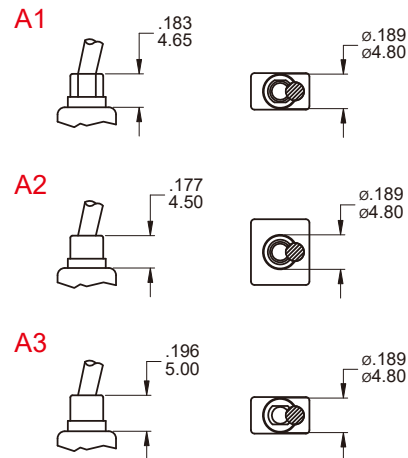

PLASTIC ACTUATOR

BUSHING OPTIONS

A1, A3 FOR SPDT / A2 FOR DPDT

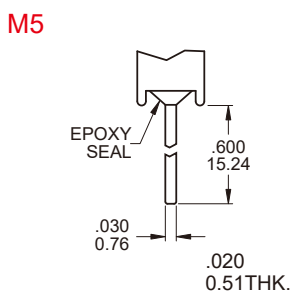
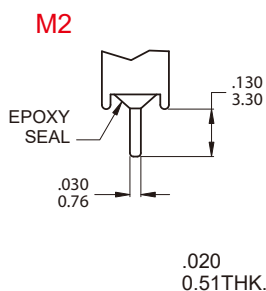
TERMINATION OPTIONS

OTHER TERMINATION OPTIONS

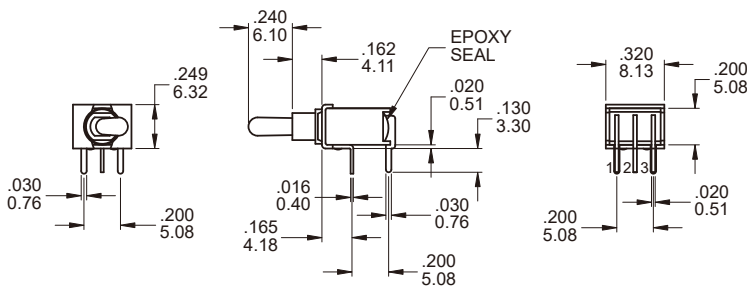
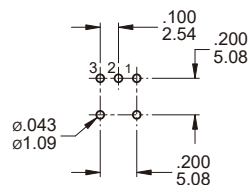
- M6** Right angle P.C. Mount
- M6N** Right angle P.C. Mount
Snap-in bracket
- M7** Vertical right angle P.C. Mount
- M7N** Vertical right angle P.C. Mount
Snap-in bracket
- VS2** Vertical bracket P.C. Mount

M6

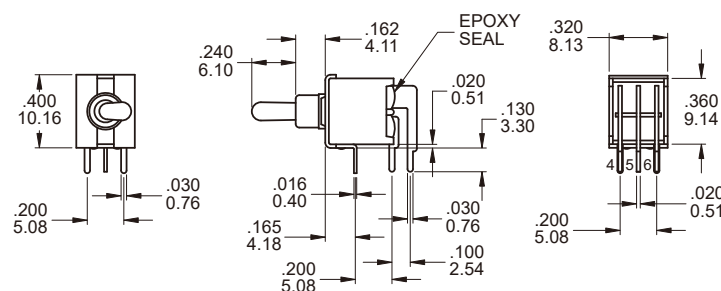
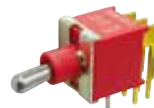
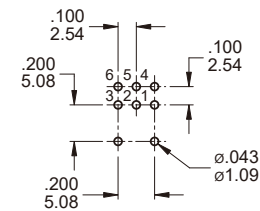
P.C. MOUNTING

SPDT

Part No. Shown : 2AS1T2A1M6QES

M6

P.C. MOUNTING

DPDT

Part No. Shown : 2AD1T2A2M6RES

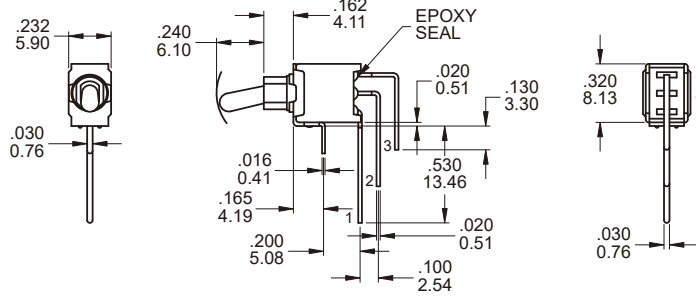

M7



P.C. MOUNTING

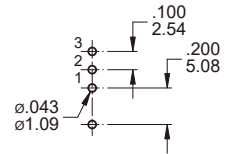

SPDT

Part No. Shown : 2AS1T2A1M7RES

M7

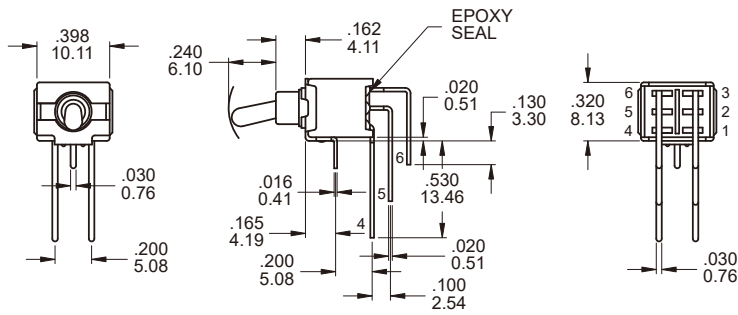
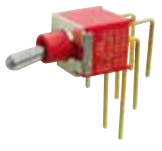

P.C. MOUNTING

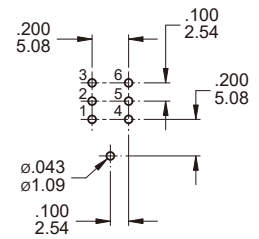

DPDT

Part No. Shown : 2AD1T2A2M7QES

VS2

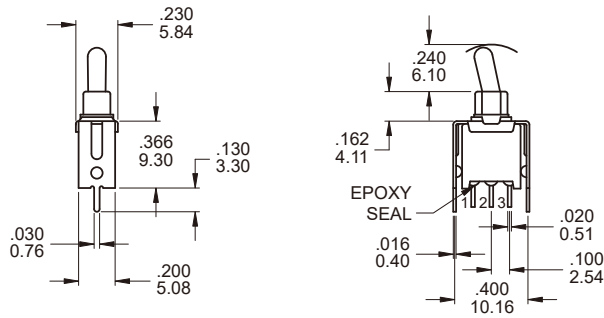

P.C. MOUNTING

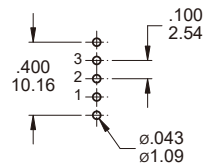

SPDT

Part No. Shown : 2AS1T2A1VS2RES

VS2

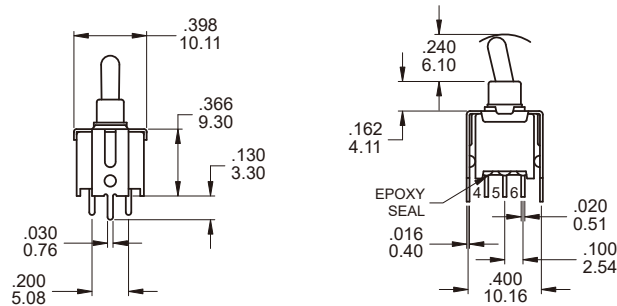

P.C. MOUNTING

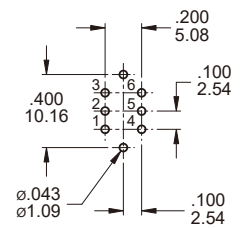

DPDT

Part No. Shown : 2AD1T2A2VS2QES

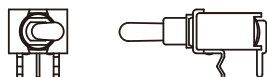
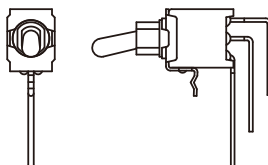
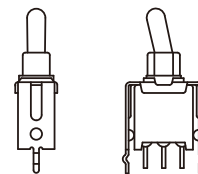
SNAP-IN TERMINATION OPTIONS
M6N

M7N

V2N

CONTACT MATERIAL OPTIONS

	CONTACT PLATING	TERMINAL PLATING	RATINGS
Q	Silver	Gold flash over silver	3 Amps with resistant load @ 120VAC or 28VDC
C	Gold over Silver	Gold over silver	1 Amps with resistant load @ 250VAC
R	Gold	Gold	0.4 Volt - Amps (VA) max. @ 20V max. (AC or DC)

SOLDERING PROCESSES

MANUAL SOLDERING: Use soldering iron of 30 watts, controlled at 350°C approximately 5 seconds while applying solder.

WAVE SOLDERING: Recommended Soldering Temperature: 270 ± 5°C

Duration of Solder Immersion: Max 5 sec. (PCB is 1.6mm in thickness)